

## **INTRODUCTION**

The Bolex H-16 Rex 5 is a 16mm reflex camera. The optical system permits through the lens viewing at all times. It is an extremely versatile, portable, dependable, well built camera. The self-threading allows easy loading of daylight spools. This camera's features include single frame, extended exposure, slow motion, a variable shutter, and backwind. Media Loan has H-16 Bolex cameras, zoom lenses, many prime lenses, and a double system sync package with 400' foot magazines as well as other accessories.

**Table of Contents**

**INTRODUCTION ..... 1**

**REFLEX VIEWFINDER ..... 3**

**DIOPTER ADJUSTMENT ..... 3**

**DOUSER ..... 3**

**TURRET ..... 4**

**FILTERS ..... 4**

**CAMERA MOTOR ..... 5**

**FILM SPEEDS ..... 5**

**RELEASE SELECTOR(ON/OFF) ..... 5**

**VARIABLE SHUTTER ..... 6**

**LAP DISSOLVE ..... 7**

**LOADING THE CAMERA ..... 7**

**CAMERA DIAGRAM ..... 8**

**FOOTAGE COUNTER ..... 9**

**FRAME COUNTER ..... 9**

**TROUBLESHOOTING ..... 9**

**REFERENCE ILLUSTRATIONS ..... 10**

**WRITTEN TEST ..... 11**

**OPERATIONAL PROFICIENCY TEST ..... 11**

Written by: Michael Majoros/Marge Brown  
Graphics and Compilation by: Marge Brown/Keith Ogren  
Additional Information by: Alley Hinkle/Kathleen Doherty

---

**Media Loan                      The Library Group                      (360)867-6253**  
**The Evergreen State College                      Olympia, WA 98505**

---

*<http://www.evergreen.edu/media>*

*10.5.00*

## REFLEX VIEWFINDER

The optical system of the Bolex H16 reflex permits through the lens viewing at all times. This system utilizes a beam splitter so the image seen in the viewfinder is completely free from flicker. The reflex finder enables accurate focusing and framing, and allows you to estimate the depth of field. The reflex prism deflects 20-25% of the light passing through the lens into the viewfinding system. Only 75-80% reaches the film plane. The actual quantity of light reaching the film is reduced by about 1/3 to 1/2 of an f-stop. To compensate for this, Bolex has determined that the effective shutter speed for the H16 camera is 1/80 second rather than the standard 1/50 of a second. To further confuse matters, Bolex (in conjunction with Kern/Switar) has designed a series of lenses which are calibrated to pass 1/3 to 1/2 stop more light than the aperture markings on the barrel indicate, compensating for the light lost to the viewfinding system.

These lenses are designated by the letters "rx" after the name on the barrel. When using these lenses with the H16 camera, the effective exposure is back to 1/50 of a second.

	Bolex H16	Other Camera
<b>RX</b>	Read exposure meter at 1/50 second	Under expose film by 1/3 to 1/2 stop
<b>Non RX</b>	Read exposure meter at 1/80 second	Read exposure meter at 1/50 second

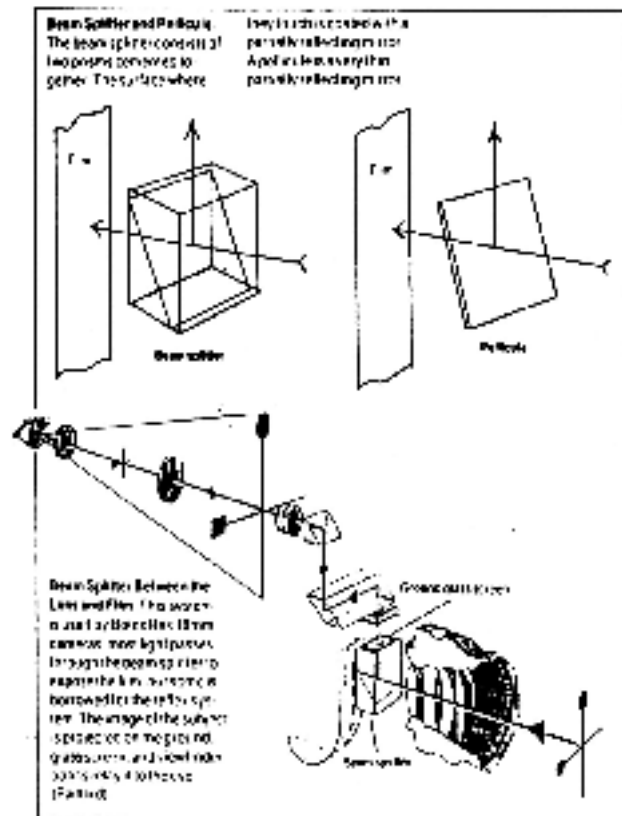

Independent Focusing

## DIOPTRIC ADJUSTMENT

This adjustment corrects the optical system to the operator's eyesight (whether or not s/he wears glasses) and remains the same for all lenses on the camera.

### To set the diopter:

1. Turn the turret to expose the reflex prism (no lens in taking position).
2. View a well lighted subject.
3. Loosen the grooved ring around the viewfinder and turn the lever until the grain of the ground glass is perfectly sharp.
4. Tighten the ring which acts as a lock nut. Some the viewfinders have locking screws.

## DOUSER

The douser (located on the reflex viewfinder) closes the eyepiece to keep light from reaching and fogging the film plane through the viewfinder.

It is necessary to use the douser when doing pixilation with a strong light behind the camera. The douser is open when the lever is in the horizontal position; closed in the vertical position.

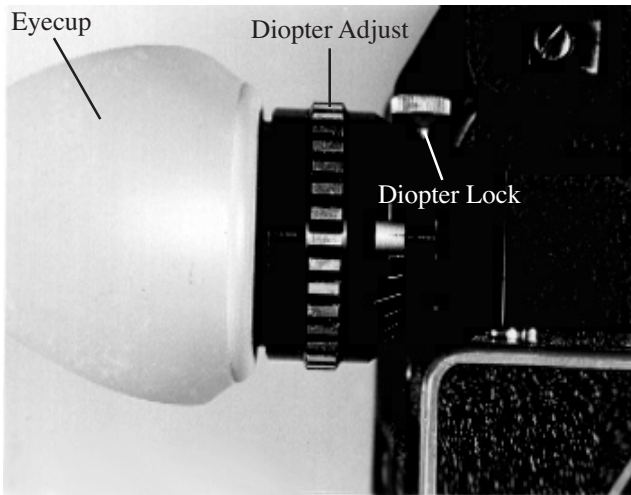

## TURRET

By turning the turret you can change from one lens to another. To turn the turret, use its fold away lever rather than handling the lenses. In this way, there is less risk of accidentally changing the aperture and/or focus ring. When using heavy lenses, such as telephotos or zooms, the turret should be locked with either a special locking clamp or a turret plug. Turret plugs go onto the lowest lens cavity (when turret is on normal position), they are marked with a red ring. For other lighter lenses, the turret lock on the camera should be sufficient. This lock is located above the lens in the taking position and should be tightened after the lenses are in place. Keep the wide-angle lens and the telephoto lens opposite each other on the turret so the telephoto lens does not interfere with field of view of the wide angle lens.

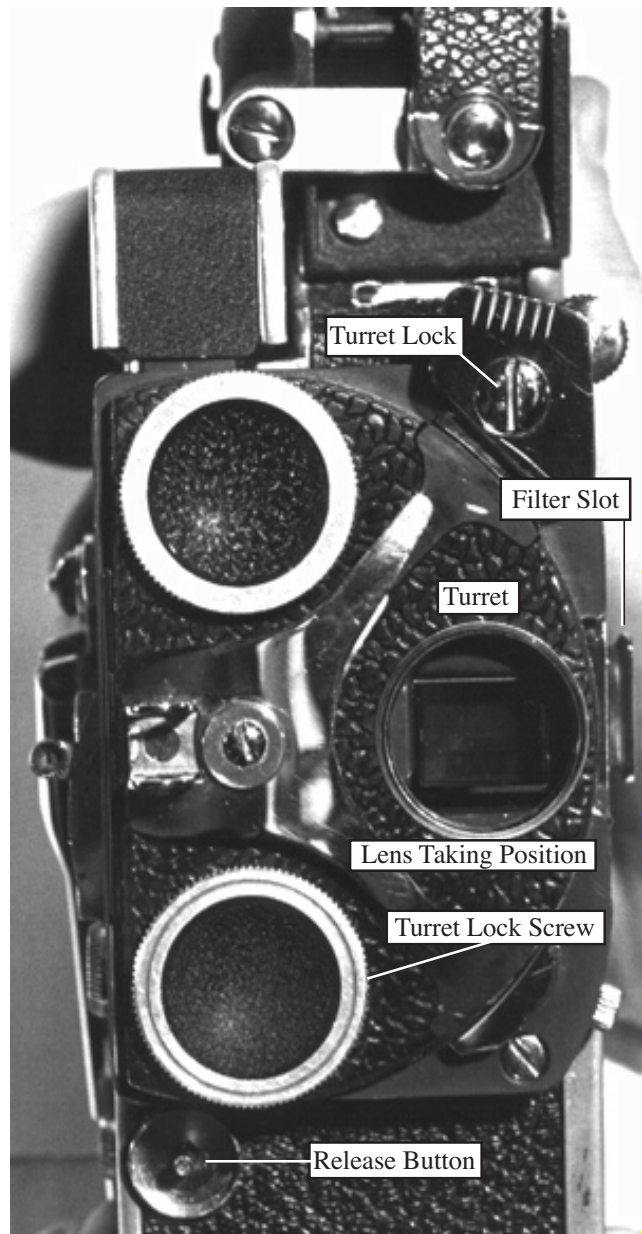

## FILTERS

The h16 camera has a filter between the taking lens position and the reflex prism. The filters therefore remain in place no matter which lens is used. When filming without a filter, an empty filter carrier should be left in the filter slot to prevent light from entering the slot and fogging the film. Make sure the carrier is located firmly within the slot and the correct filter is in place before shooting. An incorrect filter will either alter the color balance or exposure.

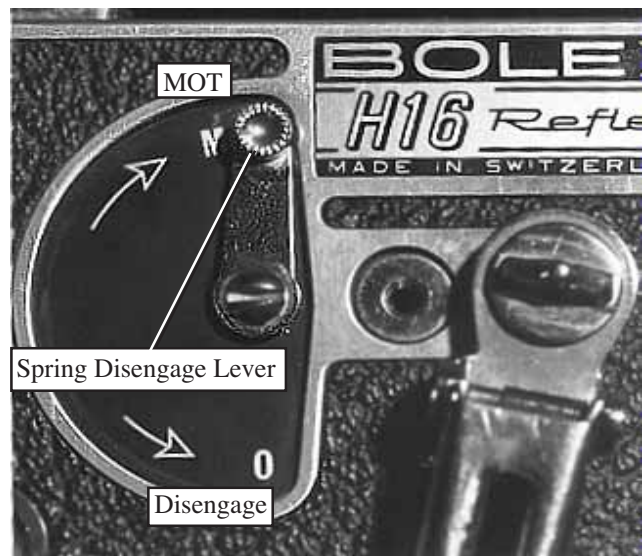
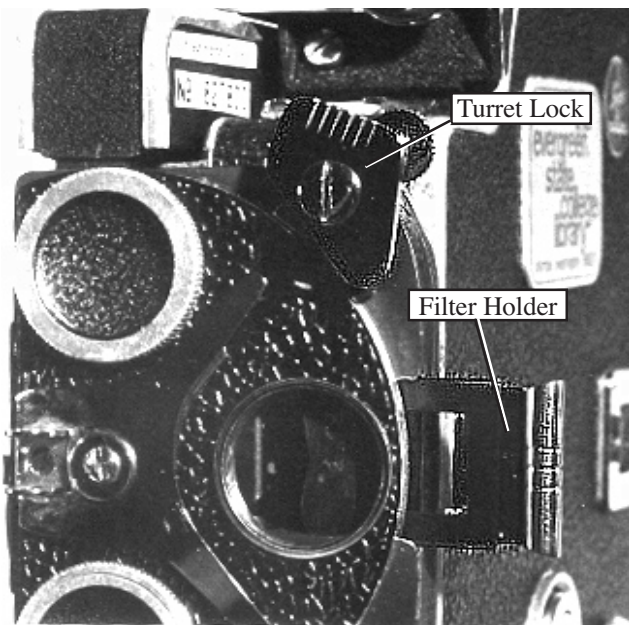

### CAMERA MOTOR

The Bolex h16 has its own internal spring drive motor. This allows an electric motor to be used and also allows you to backwind the film for camera dissolves. Turn the motor disengaging lever to "MOT" and move the side release to "stop". If the side release will not go to stop, slightly wind the spring. Lift the winding crank which automatically engages the spindle, and turn counter clockwise. Wind the spring fully without forcing it. Fold the crank and secure it on the latch on the lower body. Fully wound, the motor will drive about 18 feet to film through the camera (about 28 secs. at 24fps).

**IMPORTANT:** Never leave the camera wound during storage. This may ruin the spring. When running down the spring with no film in the camera, set film speed at 8fps.

### FILM SPEEDS

The camera has seven filming speeds from 12-64 frames per second (fps). To select the desired speed, turn the control knob until the corresponding figure is opposite the red dot. When changing filming speeds do not forget to alter the exposure setting. (When changing from 24 to 32 fps open diaphragm 1/2; from 24 to 48 by one stop and so forth.)

### RELEASE SELECTOR(ON/OFF)

The H16 can be used for normal, continuous, or single frame filming. The different operations are controlled by the side release.

Normal filming-- This method is suitable for most shooting situations. Then camera runs as long as the operator depresses the front release or pushes the side release towards 'M'.

Continuous filming-- Push the side release towards 'M' until it clicks into place. The camera will continue running until the wind runs out or the side lever is pushed to the STOP position.

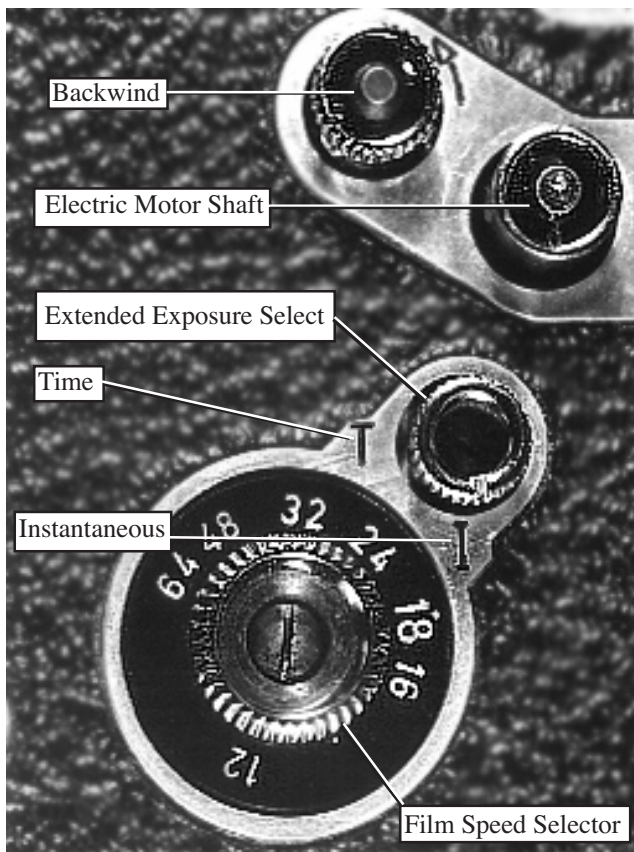

## VARIABLE SHUTTER

The H16 is equipped with a shutter whose aperture can be varied when the camera is running and when it is stopped. This enables you to reduce exposure time without altering the camera running speed or f-stop. In bright light, the variable shutter can be used to reduce exposure, therefore eliminating the need for a neutral density filter.

The shutter may be locked in each of its four positions by pulling it out and pushing in when at the desired setting.

Fully open----normal exposure--at the red mark.  
 1/4 closed----exposure reduced by one half stop.  
 1/2 closed----exposure reduced by one full stop.  
 Fully closed----no light will reach the film plane.

In some cameras, a triangular warning signal will appear in the viewfinder if the variable shutter is not in the fully open position.

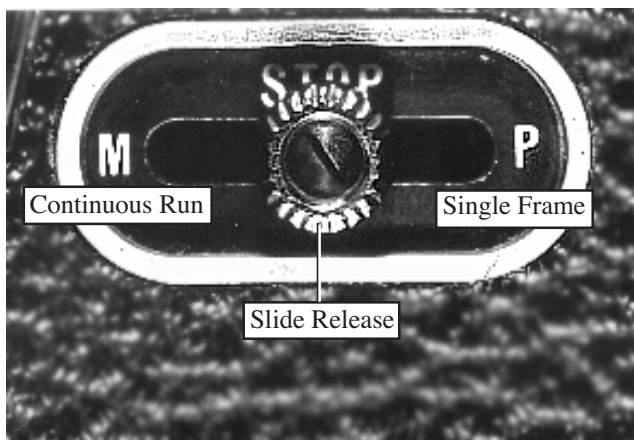

Single Frame filming---

Instantaneous: Turn the knob until the guide mark is in the I position. The effective exposure time in this position is 1/30 of a second. Time: Place guide mark in "T" position; shutter will remain open as long as side release is in the "P" position.

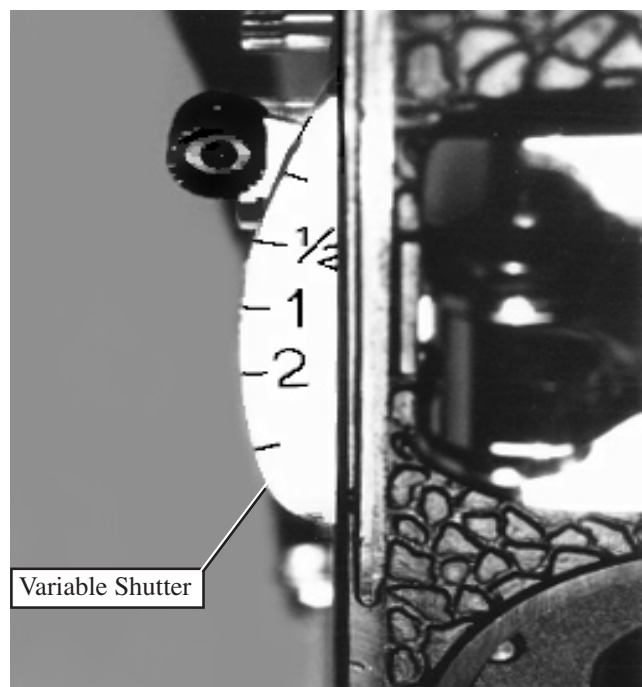

## LAP DISSOLVE

A lap dissolve is made by superimposing a fade-in on a fade-out so that one picture gradually disappears as the next gradually appears. This allows for a smooth transition during which the picture brightness scarcely varies. To produce a lap dissolve, close the first shot in a sequence with a fade out. Lock the shutter in the "closed" position. Set the frame control to zero. Disengage the motor. Set the slide release to the M position. Douse the viewfinder. Cap the lens. Rewind the film, using the backwind key, until the frame counter indicates the duration of the fade out. Move the slide release to the STOP position. Frame the second sequence to be filmed and release the slide lever. At the same time make a fade-in the same length as the fade-out.

Duration of the fade in seconds	Number of Frames/ Filming Speed	
	18 fps	24 fps
1 1/2	973	964
2	964	952
2 1/2	955	940
3	946	928

## LOADING THE CAMERA

Before loading:

1. Set side release to stop.
2. Set disengaging motor to MOT.
3. Turn FPS selector knob until the number corresponding to the desired camera speed faces the red dot.
4. Wind the camera.

check that the pressure plate pin is locked so that the pressure plate cannot open.

The film will jam at this point if the plate is not closed. Remove the empty spool from its spindle by pressing the ejector. Place the loaded daylight spool on the upper spindle. (Film should come off in the direction indicated by the engraved arrow.)

**IMPORTANT:** *At the film gate the emulsion should always face towards the front of the camera.*

Using the film knife (located at the bottom of the camera), clip the film end.

Close the loop formers by moving the control lever parallel to the pressure plate.

Insert film end in the top feed sprocket and start the camera motor. The film is automatically threaded through the gate. If you need to adjust the film, you can spread the sprocket guides by sliding the locking plate forward.

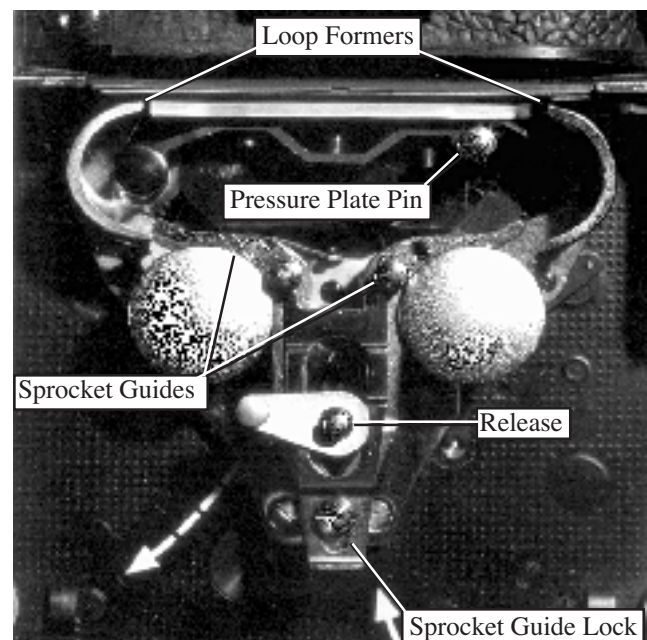

# CAMERA DIAGRAM

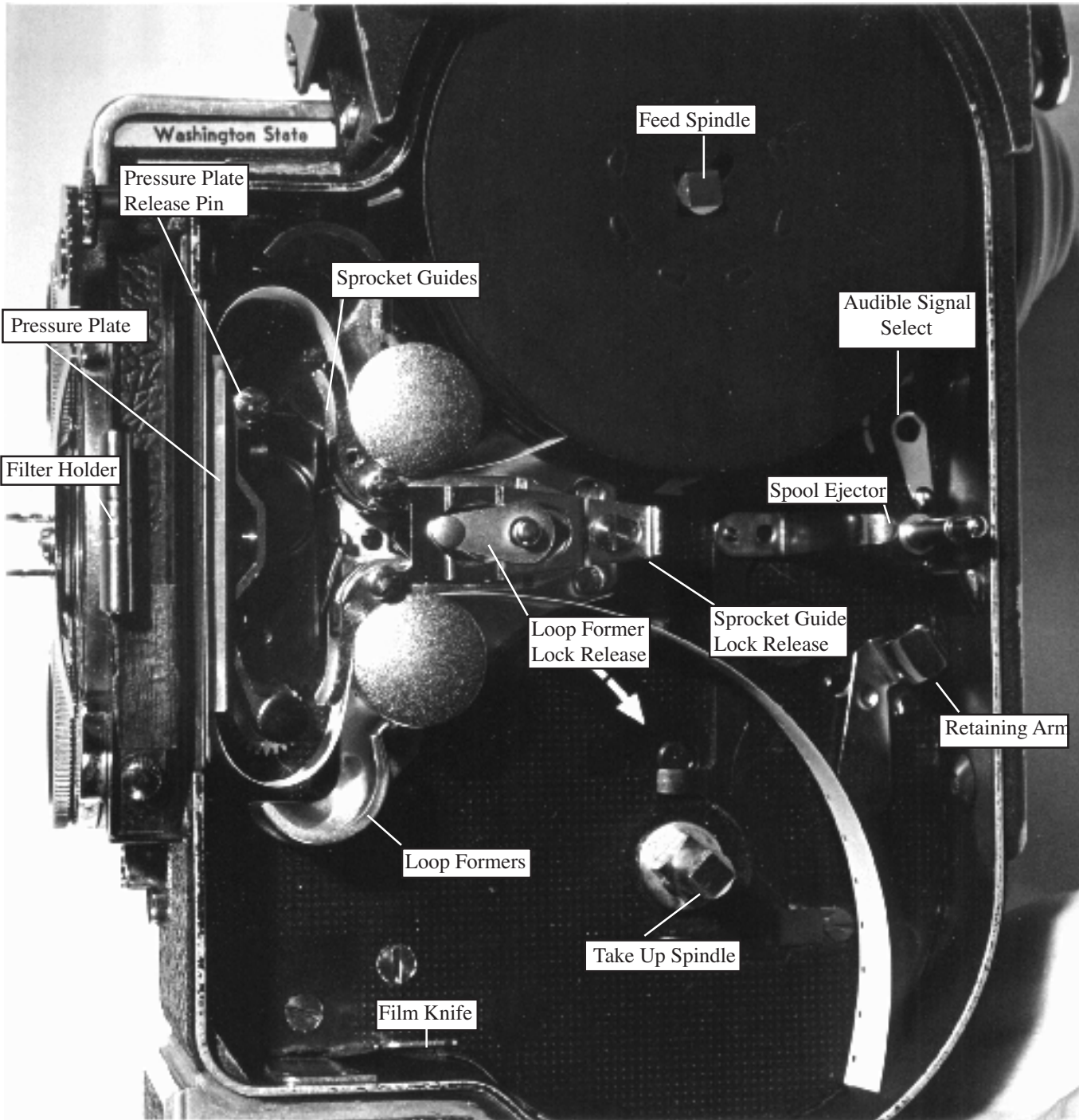



Continue to run the camera until 12 to 15 inches of film have passed through the drive mechanism.

Open the loop formers by pressing the button located on the sprocket/gate assembly. Insert the film end into the take-up spool (in the direction of the engraved arrow), Place the spool on the lower spindle and take up any slack by hand. Run the camera again for several seconds to make sure that everything is OK (check that the film is advancing normally and the loops do not scrape the body). Replace and lock the lid.

### FOOTAGE COUNTER

The footage counter indicates how much film has been exposed. Once the camera has been loaded, the counter will read FEET. Run the camera until the figure "0" appears opposite the white line in the indicator window. This indicates the film leader has been taken up and the camera is ready to be used.

The counter will automatically return to "0" when the lid is removed.

When shooting at 24 fps, there is the option for an audible CLICK every second indicating that 8 inches of film has passed through the camera. This can be useful when timing a pan or zoom shot. For an audible CLICK, move the audible signal select lever down when loading film; for no click place the lever in the "0" position.

### FRAME COUNTER

The frame counter is helpful for lap dissolves, double exposures, and animation.

--the upper dial adds the frames in forward run and subtracts them in reverse (0 to 50 frames)  
--The lower dial totals in units of 50 frames. It will subtract when the camera runs in reverse. Indicators are from 0 to 1000 frames.

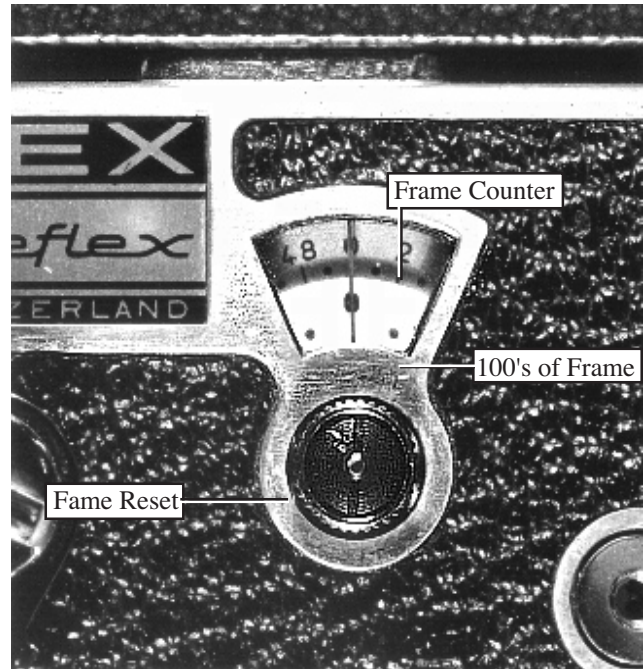

### TROUBLESHOOTING

#### Problem and Probable Cause

*Film is black:*

- Variable lens shutter was closed
- Lens cap left on
- Exposure incorrect

*Film underexposed, images reversed; with color film, general orange tint:*

Film incorrectly loaded with the base facing forward instead of the emulsion.

*Jumpy images:*

- Loops formed incorrectly
- Shrunken film stock.

*Dominant red-orange tint:*

Using tungsten lamps with a daylight film or an underpowered tungsten lamp.

*Obscured Images:*

- Turret incorrectly positioned.
- Telephoto lens on turret obscuring view of other lenses.

## TROUBLESHOOTING cont

### *Partly obscured pictures:*

Telephoto lens in the way of the taking lens or turret badly positioned.

### *Parallel scratches on the edge of the film:*

Dust or particles of emulsion in the film gate.  
Camera poorly loaded.

### *Fogged film:*

Light entering through the viewfinder or filter slot.

Film was loaded in extremely bright light.  
Camera not seated well.

### *Film fogged at edges:*

Camera loaded in strong light.

Warped take up or feed reel.  
Filter carrier not in slot during exposure.

### *Out of focus or 'breathing' picture:*

Pressure pad incorrectly locked.

## REFERENCE ILLUSTRATIONS

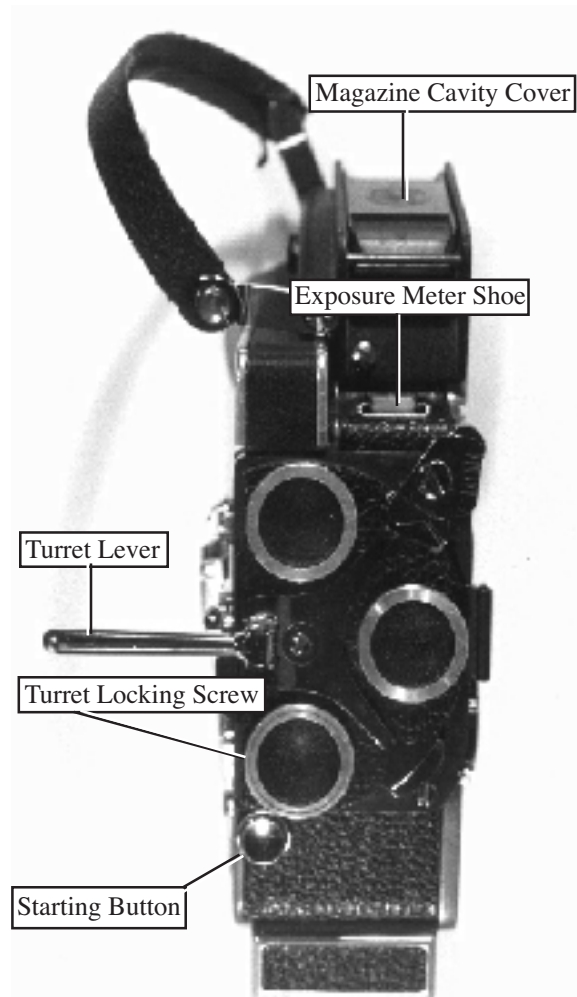
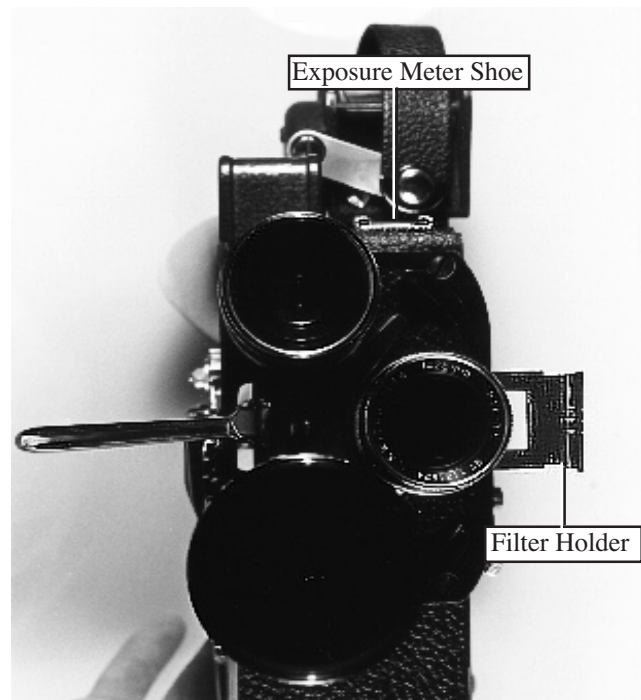
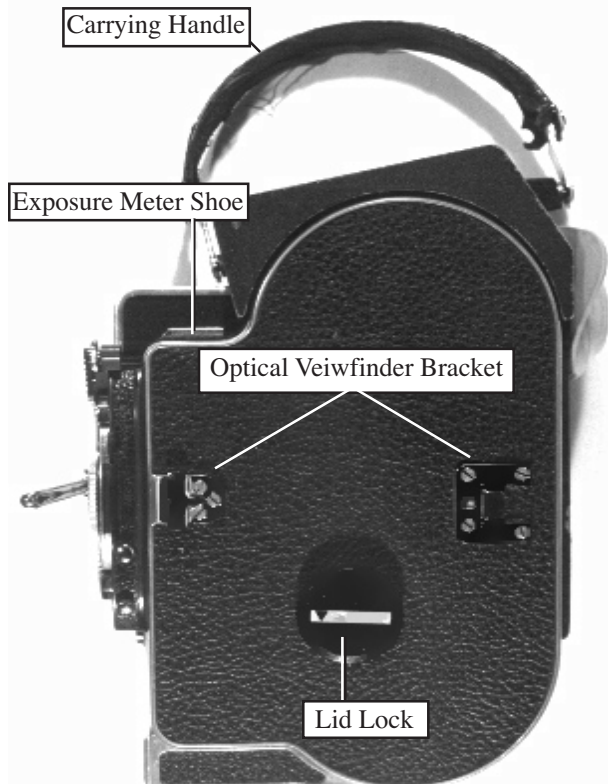

## **Please Complete the Proficiency Test Before Checking Out the Bolex H16 from Media Loan**

### **WRITTEN TEST**

1. List the four steps necessary to set the diopter adjustment.
2. How many frames per second is the Bolex capable of shooting? How few?
3. What kind of viewing system does the Bolex H16 employ?
4. What is the shutter speed of the Bolex H16?
5. Explain the difference between Bolex Rx lenses and normal lenses. What is the effect on shutter speed, and how do you compensate?
6. What is the function of the turret plug?
7. List the steps necessary to perform a lap dissolve.
8. List the steps necessary to thread the camera.
9. Describe any precautions you need to take while cleaning and operating the Bolex.
10. What is the extent of your financial responsibility in case of loss, or damage to the camera?

### **OPERATIONAL PROFICIENCY TEST**

1. Identify all of the parts and control of the Bolex H16.
2. Set the diopter and place the 85b filter in the camera.
3. Set the fps at '24'.  
Set the counter at '0'.
4. Load film in the camera.
5. Demonstrate how to create a lap dissolve.
6. Demonstrate extended exposure and animation features.
7. Demonstrate proper lens mounting to insure proper 'taking' balance.